

MINISTÉRIO DO PLANEJAMENTO, ORÇAMENTO E GESTÃO  
DIRETORIA DE ADMINISTRAÇÃO  
COORDENAÇÃO-GERAL DE ADMINISTRAÇÃO PREDIAL  
COORDENAÇÃO TÉCNICA DE MANUTENÇÃO PREDIAL  
DIVISÃO DE PROJETOS

TERMO DE REFERÊNCIA PARA AQUISIÇÃO DE MOBILIÁRIO  
ANEXO II - DESENHOS TÉCNICOS

GRUPO I – ESTAÇÕES, MESAS E PLATAFORMAS DE TRABALHO

1. ESTAÇÕES DE TRABALHO (altura: 75cm)



Figura 01  
Estação de Trabalho ETA 1-A - 160X140X60cm  
Vista superior | Escala 1:50



Figura 02  
Estação de Trabalho ETA 1-B - 160X140X60cm  
Vista superior | Escala 1:50

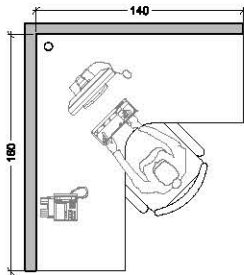

**Figura 03**  
**Estação de Trabalho ETA 2T-A - 160X140X60cm**  
 Vista superior | Escala 1:50

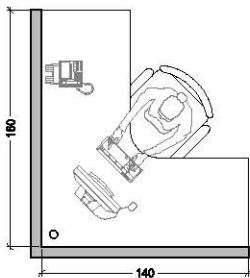
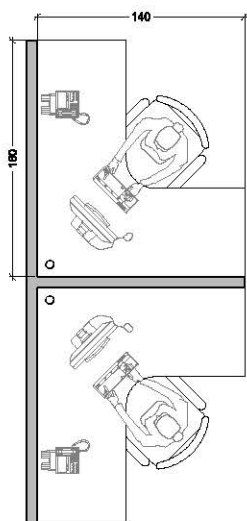
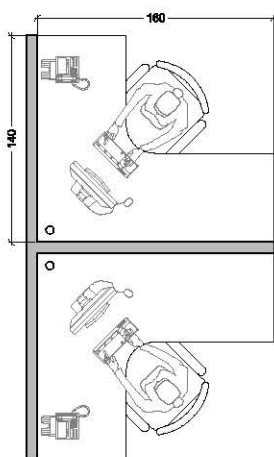

**Figura 04**  
**Estação de Trabalho ETA 2T-B - 160X140X60cm**  
 Vista superior | Escala 1:50

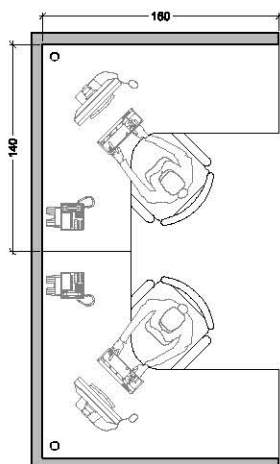

**Figura 05**  
**Estação de Trabalho ETA 2U-A - 160X140X60cm**  
 Vista superior | Escala 1:50



Figura 06  
**Estação de Trabalho ETA 2U-B - 160X140X60cm**  
 Vista superior | Escala 1:50



Figura 07  
**Estação de Trabalho ETA 4 - 160X140X60cm**  
 Vista superior | Escala 1:50

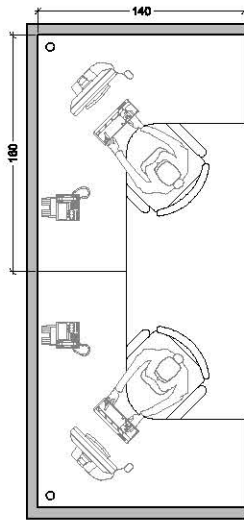

Figura 08  
**Estação de Trabalho ETB 1 - 140X140X60cm**  
 Vista superior | Escala 1:50

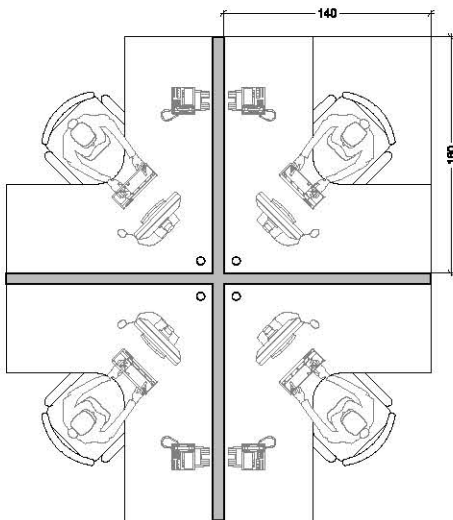

**Figura 09**  
**Estação de Trabalho ETB 2T - 140X140X60cm**  
 Vista superior | Escala 1:50

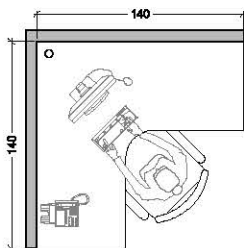
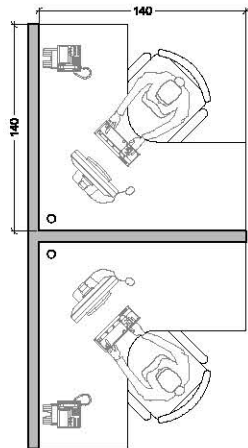
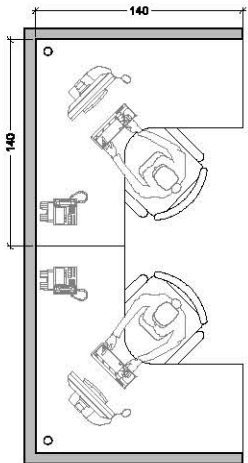

**Figura 10**  
**Estação de Trabalho ETB 2U - 140X140X60cm**  
 Vista superior | Escala 1:50

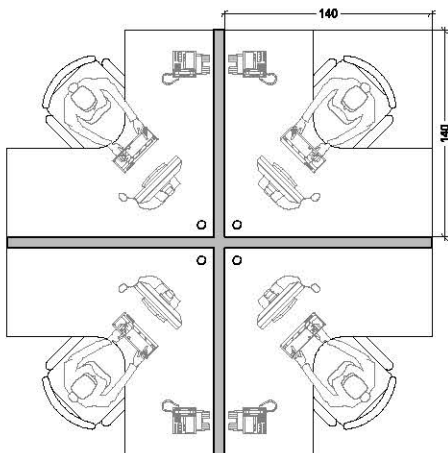

**Figura 11**  
**Estação de Trabalho ETB 4 -**  
**140X140X60cm**  
 Vista superior | Escala 1:50

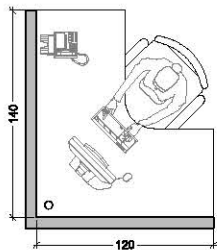

**Figura 12**  
**Estação de Trabalho ETC 1-A em L -**  
**140X120X60cm**

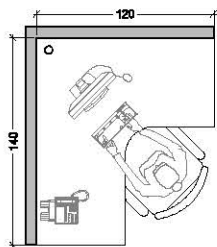

**Figura 13**  
**Estação de Trabalho ETC 1-B em L -**  
**140X120X60cm**  
 Vista superior | Escala 1:50

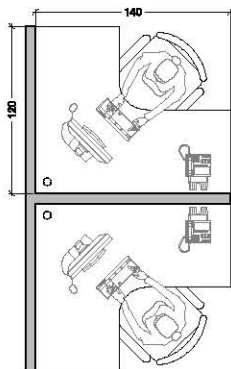

**Figura 14**  
**Estação de Trabalho ETC 2T-A em T -**  
**140X120X60cm**  
 Vista superior | Escala 1:50

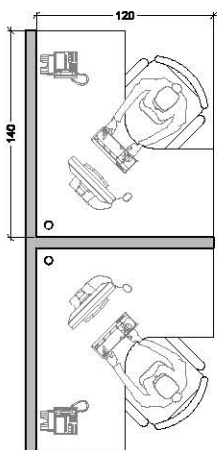

**Figura 15**  
**Estação de Trabalho ETC 2T-B em T**  
**140X120X60cm**  
 Vista superior | Escala 1:50



Figura 16  
**Estação de Trabalho ETC 2U em U**  
**140X120X60cm**  
 Vista superior | Escala 1:50



Figura 17  
**Estação de Trabalho ETC 4 -**  
**140x120x60cm**  
 Vista superior | Escala 1:50

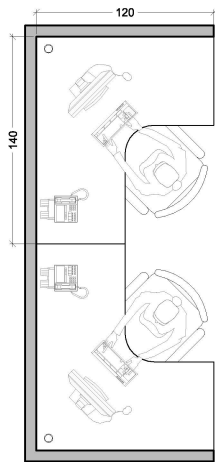

Figura 18  
**Tampo Balcão Retangular**  
 Dimensões: TBS1 - 160x30cm  
 TBS2 - 140x30cm  
 TBS3 - 120x30cm

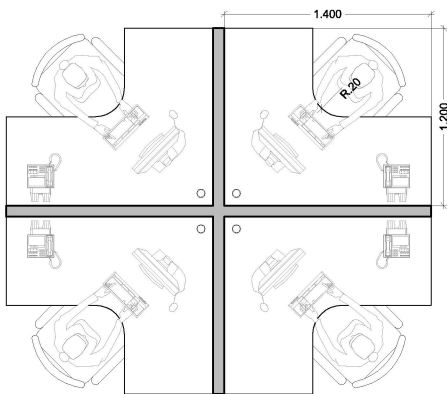

Figura 19  
**Prateleiras Suspensas**  
 Dimensões: PS1 - 60x30cm  
 PS2 - 40x30cm

## 2. Mesas de Trabalho Retangulares (altura: 75cm)

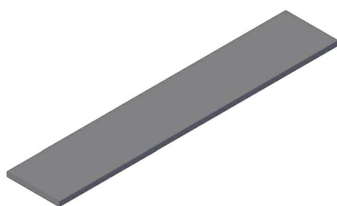

Figura 20

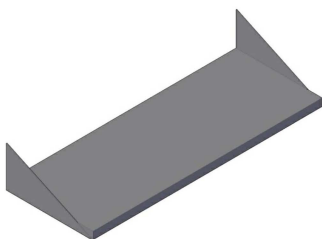
Dimensões: MT1 - 180x80cm  
MT2 - 160x80cm  
MT3 - 140x80cm  
MT4 - 120x60cm  
MT5 - 100x60cm  
MT6 - 80x60cm

## 3. Mesa de Trabalho em "L" (altura: 75cm)



Figura 21

Dimensões: ML1 - 160x160x70cm  
ML2 - 160x140x70cm  
ML3 - 140x140x60cm  
ML4 - 140x120x60cm  
ML5 - 120x120x60cm



Figura 22

Mesa de Trabalho em "L" ML 2-A  
160x140x70cm

Vista superior | Escala 1:50

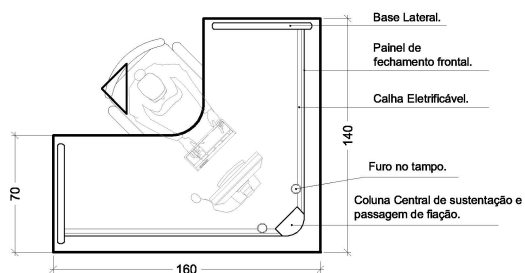

Figura 23

Mesa de Trabalho em "L" ML 2-B  
160x140x70cm

Vista superior | Escala 1:50

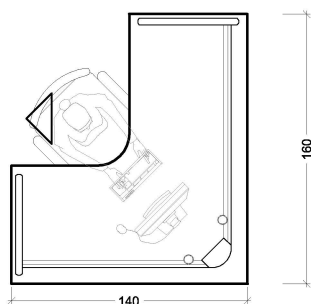

Figura 24  
**Mesa de Trabalho em "L" ML 4-A**  
**140x120x60cm**  
 Vista superior | Escala 1:50



Figura 25  
**Mesa de Trabalho em "L" ML 4-B**  
**140x120x60cm**  
 Vista superior | Escala 1:50

#### 4. Mesa de Reunião Redonda (altura: 75cm)

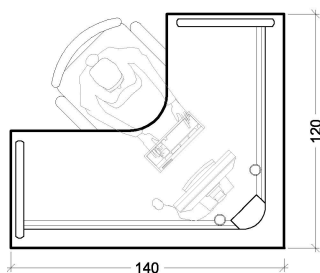

Figura 26  
 Dimensões: MRRd1 - 140cm  
 MRRd2 - 120cm  
 MRRd3 - 100cm

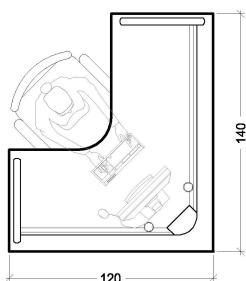
#### 5. Mesas de Reunião Retangular (altura: 75cm)



Figura 27  
**Mesa retangular (tampo único)**  
**MRRt 1 - 200X100cm**  
 Vista superior | Escala 1:50



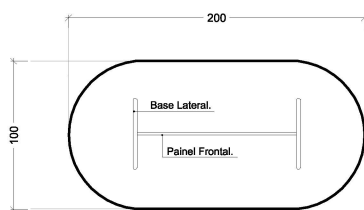

Figura 27

**Mesa retangular (tampo único com calha e caixa de tomadas)**

**MRRt 2 - 200X100cm**

Vista superior | Escala 1:50

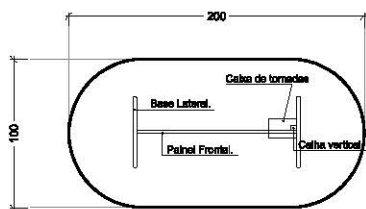

Figura 28

**Mesa de retangular (tampo único)**

**MRRt 3 - 220x120cm**

Vista superior | Escala 1:50

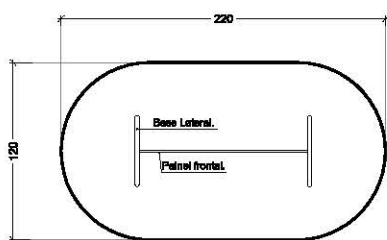

Figura 28

**Mesa de retangular (tampo único com calha e caixa de tomadas)**

**MRRt 4 - 220x120cm**

Vista superior | Escala 1:50

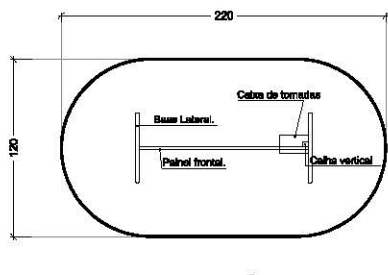

Figura 29

**Mesa retangular (tampo externo semicircular)**

**MRRt 5 - 120x120cm**

Vista superior | Escala 1:50

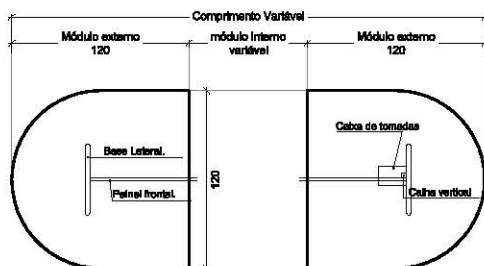

Figura 30  
**Mesa retangular (tampo interno retangular)**  
**MRRt 6 - 60x120cm**  
 Vista superior | Escala 1:50



Figura 31  
**Mesa de retangular (tampo interno retangular com calha e caixa de tomada)**  
**MRRt 7 - 60x120cm**  
 Vista superior | Escala 1:50

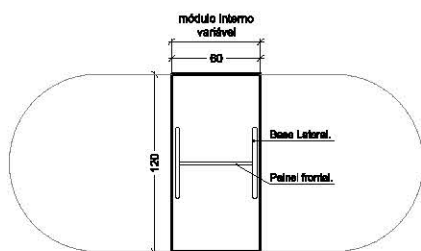

Figura 32  
**Mesa de retangular (tampo interno retangular)**  
**MRRt 8 - 80x120cm**  
 Vista superior | Escala 1:50

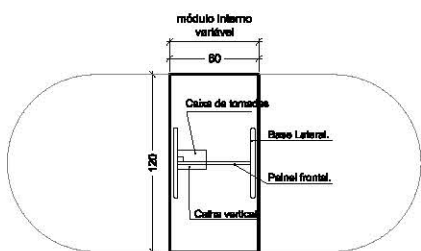

Figura 33  
**Mesa de Reunião Retangular (tampo interno retangular com calha e caixa de tomada)**  
**MRRt 9 - 80x120cm**  
 Vista superior | Escala 1:50

## 6. Mesa para Impressora (altura: 75cm)

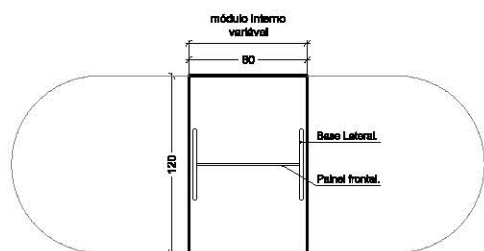

Figura 34  
Corte | Escala 1:50

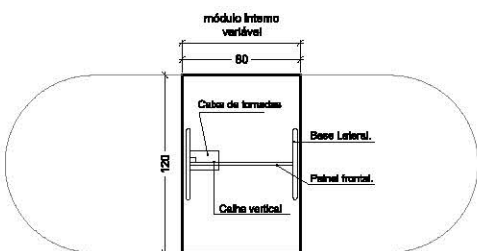

Figura 35  
Vista superior | Escala 1:50

Mesa para Impressora- Mimp 1 - 60x45cm  
Mimp 2 - 70x60cm  
Mimp 3 - 80x70cm

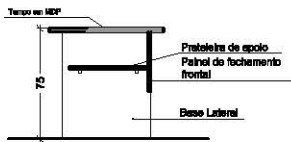
## 7. Mesa componível trapezoidal (altura: 75cm)

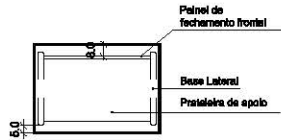

Figura 36  
Mesa componível Trapezoidal (com calha na largura menor)  
MCT 1 - 80x250x90cm  
Vista superior | Escala 1:50



Figura 37  
Mesa componível Trapezoidal (com calha na largura maior)  
MCT 2 - 80x250x90cm  
Vista superior | Escala 1:50

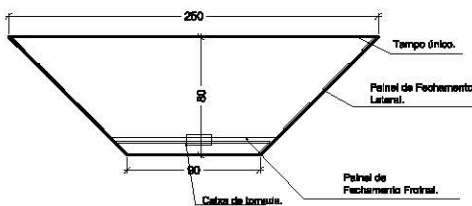

Figura 38  
Mesa componível Trapezoidal (para fechamento)  
MCT 3 - 80x170x90cm  
Vista superior | Escala 1:50

## 9. Plataforma de trabalho de 4 Lugares (altura: 75cm)

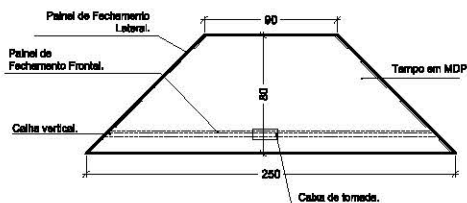

Figura 40

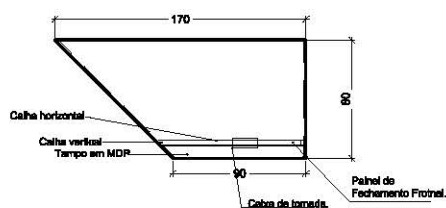
Plataforma de trabalho para 4 lugares- PT4 1 - 140x320cm  
PT4 2 - 140x280cm  
PT4 3 - 140x240cm

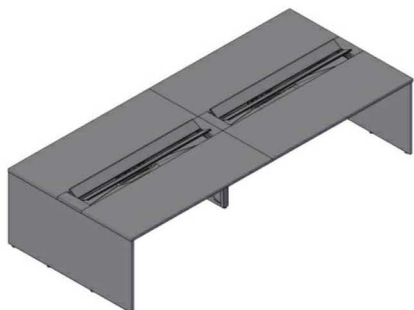

Figura 41

Plataforma de trabalho para 2 lugares- PT2 1 - 140x160cm  
PT2 2 - 140x140cm  
PT2 3 - 140x120cm

## 10. Divisória Modulada com fechamento em vidro (DV)

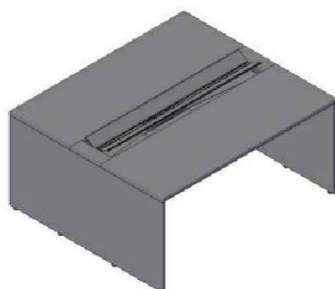

Figura 41

## 11. Mesa de Trabalho Retangular Madeirada (altura: 75cm)

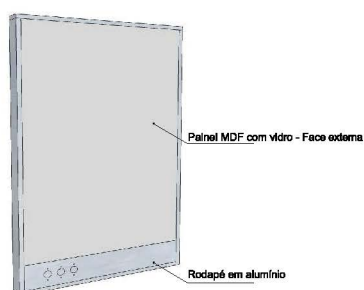

Figura 42

Mesas de trabalho retangular madeirada- MRM1 - 90x220cm

MRM2 - 90x180cm

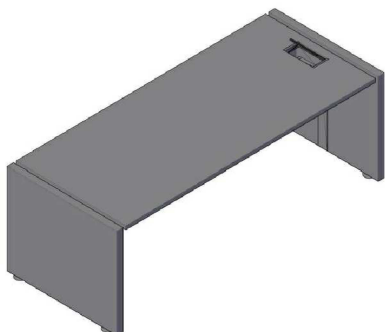

Figura 43

Mesa Auxiliar Retangular Madeira-  
MAM - 50x90cm

# GRUPO II - ARMÁRIOS, APARADORES E GAVETEIROS

## 1. Armários

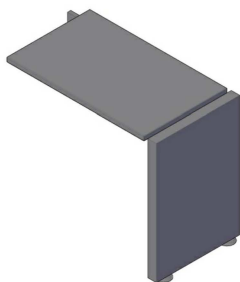
### Armário - ABB - 75x45x80cm



Figura 44  
Vista superior | Escala 1:50



Figura 45  
Elevação | Escala 1:50

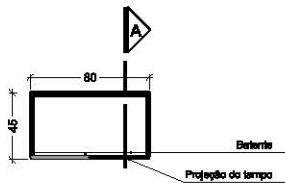

Figura 46  
Corte | Escala 1:50

### Armário - AB - 110x45x80cm

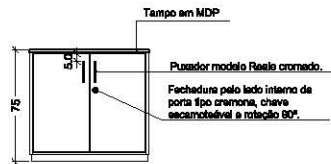

Figura 47  
Vista superior | Escala 1:50

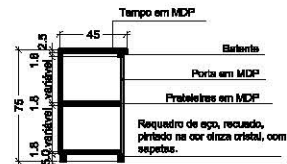

Figura 48  
Elevação | Escala 1:50

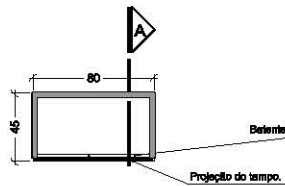

Figura 49  
Corte | Escala 1:50

### Armário - AM - 160x45x80cm

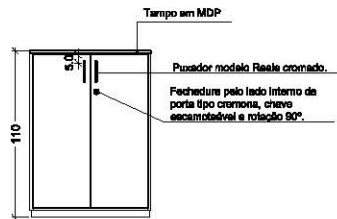

Figura 50  
Vista superior | Escala 1:50

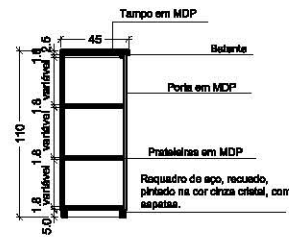

Figura 51  
Elevação | Escala 1:50

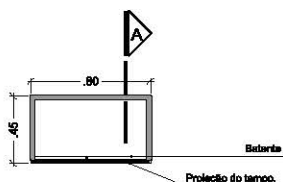

Figura 52  
Corte | Escala 1:50

## Armário - AA - 210x45x80cm

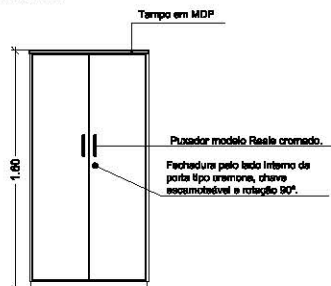

Figura 53  
Vista superior | Escala 1:50

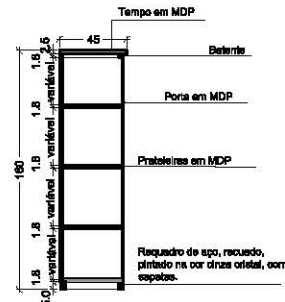

Figura 54  
Elevação | Escala 1:50

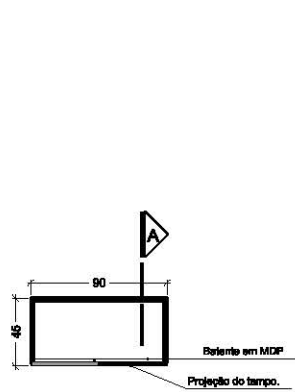

Figura 55  
Corte | Escala 1:50

## 2. Arquivo para pasta suspensa

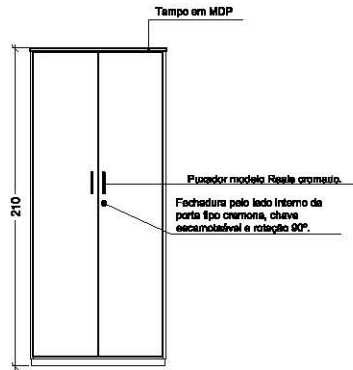
### Arquivo - APS - 160x60x50cm

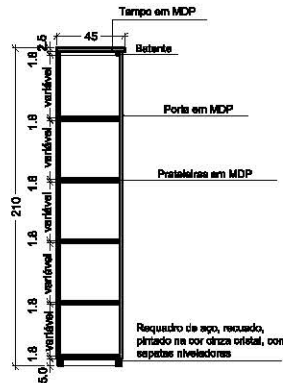

Figura 56  
Vista superior | Escala 1:50



Figura 57  
Elevação | Escala 1:50

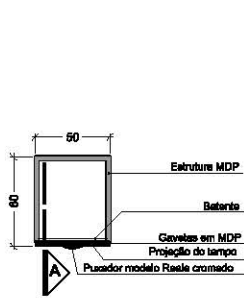

Figura 58  
Corte | Escala 1:50

## 3. Armário - AE

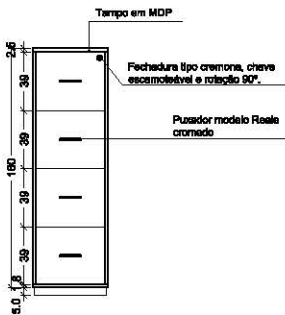
### Armário - AE 1 - 210X45x90cm

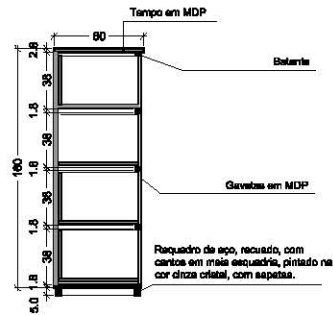

Figura 59  
Vista superior | Escala 1:50



Figura 60  
Elevação | Escala 1:50

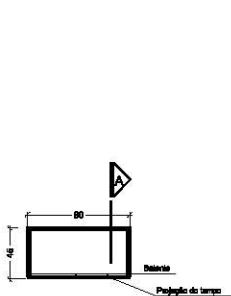

Figura 61  
Cortes | Escala 1:50

## Armário - AE 2 - 210x45x120cm

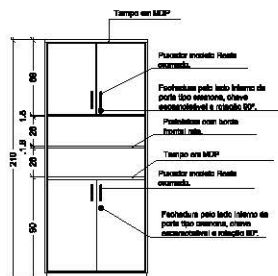

Figura 62  
Vista superior | Escala 1:50

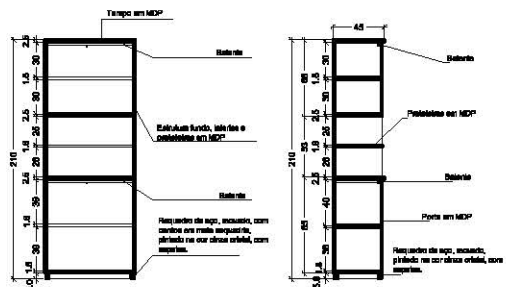

Figura 63  
Elevação | Escala 1:50

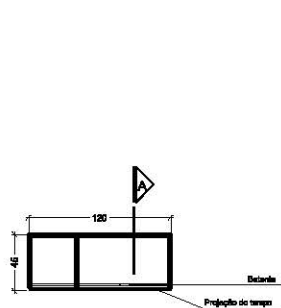

Figura 64  
Corte | Escala 1:50

## 4. Aparador

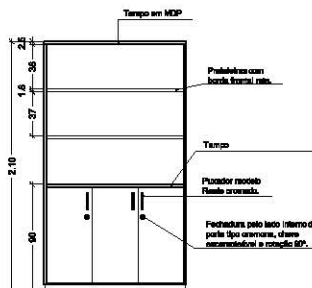
### Aparador - AP 1 - 45x80cm

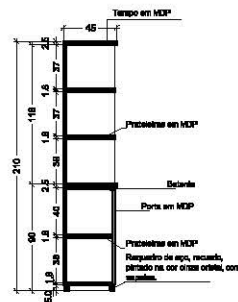

Figura 65  
Vista superior | Escala 1:50



Figura 66  
Elevação | Escala 1:50

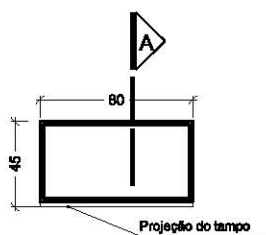

Figura 67  
Corte | Escala 1:50

### Aparador - AP 2 - 45x120cm

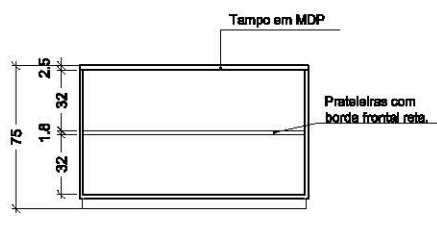

Figura 68  
Vista superior | Escala 1:50



Figura 69  
Elevação | Escala 1:50

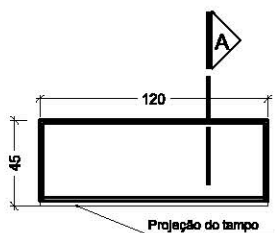

Figura 70  
Corte | Escala 1:50

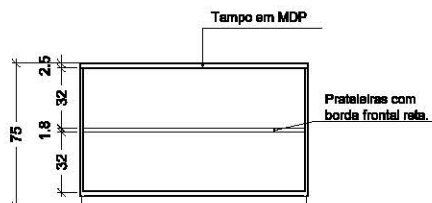

## 5. Gaveteiros

### Gaveteiro - GV 1 - 66x60x30cm



Figura 71  
Vista superior | Escala 1:50



Figura 72  
Elevação | Escala 1:50

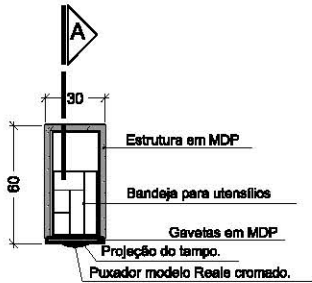

Figura 73  
Corte | Escala 1:50

### Gaveteiro - GV 2 - 66x60x40cm

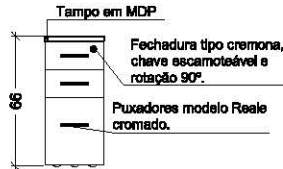

Figura 74  
Vista superior | Escala 1:50



Figura 75  
Elevação | Escala 1:50

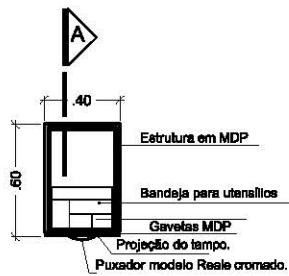
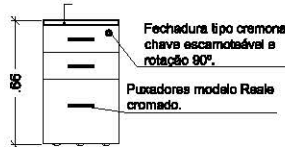
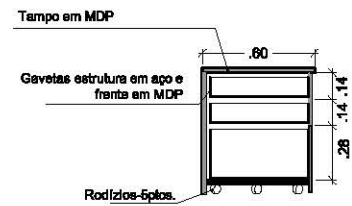

Figura 76  
Corte | Escala 1:50